

ACCESSORIES

TIVA8-MD

WASHER DISINFECTOR

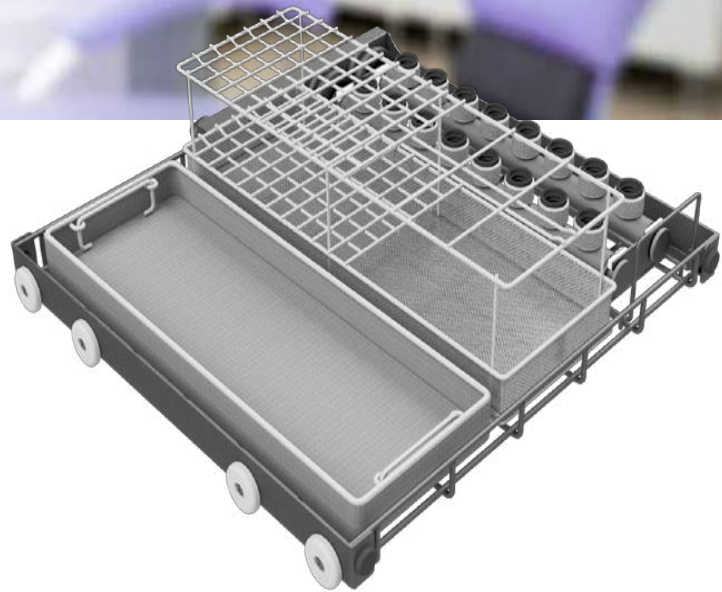

Racks

TH148 LOWER WASH RACK

Washing rack positioned on the lower level, basic version
For various inserts and accessories.

Product code	119905148
Internal loading dimensions with upper rack WxDxH	500x475x230 mm
Internal loading dimensions without upper rack WxDxH	500x475x470 mm
Rack external dimensions WxDxH	525x502x48 mm
Empty rack weight	2,5 Kg



Configuration example with:
2x A085 + 1x A053

TH156 LOWER WASH RACK 2 CONN.

Washing rack positioned on the lower level, with 2 connection
Left-hand side free for various inserts (475x215 mm).
Active drying of turbines, hand-pieces and contraangles.
For various inserts and accessories.

Product code	119905156
Internal loading dimensions with upper rack WxDxH	500x430x230 mm
Internal loading dimensions with upper rack and A076 WxDxH	360x460x230 mm
Internal loading dimensions without upper rack WxDxH	500x430x470 mm
Rack external dimensions WxDxH	525x525x72 mm
Empty rack weight	3 Kg

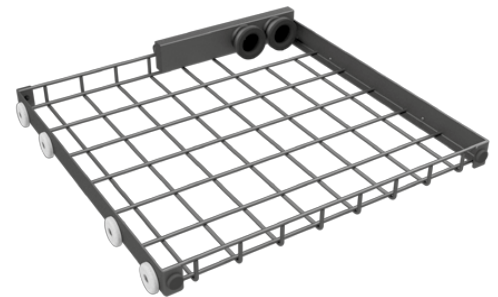

Configuration example with:
1x A085 + 1x A053 + 1x A076 + 2x A075

TH157 LOWER WASH RACK 4 CONN.

Washing rack positioned on the lower level, with 4 connection
Active drying of turbines, hand-pieces and contra-angles.
For various inserts and accessories.

Product code	119905157
Internal loading dimensions with upper rack WxDxH	500x430x230 mm
Internal loading dimensions with upper rack and A076 WxDxH	220x460x230 mm
Internal loading dimensions without upper rack WxDxH	500x430x470 mm
Rack external dimensions WxDxH	525x525x72 mm
Empty rack weight	3,5 Kg

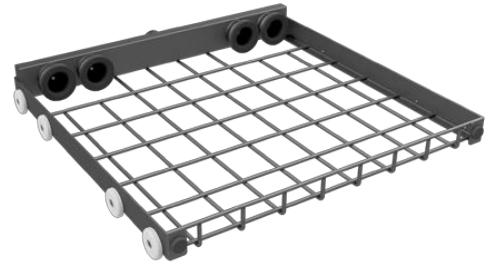

Configuration example with:
2x A076 + 4x A075 + 1x A085

TH151 UPPER WASH RACK W/S.ARM

Washing rack positioned on the upper level, with spray arm
For various inserts and accessories.

Product code	119905151
Internal loading dimensions WxDxH	480x460x185 mm
Rack external dimensions WxDxH	532x524x110 mm
Empty rack weight	3,5 Kg

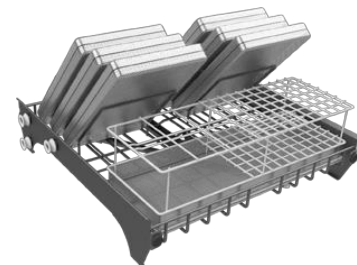
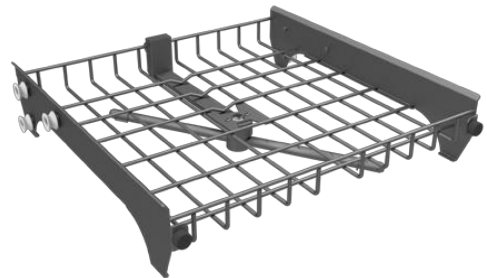

Configuration example with:
2x A065 + 1x A053

TH149 UPPER WASH RACK 2 CONN. W/S.ARM

Washing rack positioned on the upper level, with 2 connection and spray arm
 Left-hand side free for various inserts (475x215 mm). Active drying of turbines, hand-pieces and contraangles.

For various inserts and accessories.

Product code	119905149
Internal loading dimensions with A076 WxDxH	350x460x185 mm
Internal loading dimensions without A076 WxDxH	480x430x185 mm
Rack external dimensions WxDxH	532x524x110 mm
Empty rack weight	4 Kg

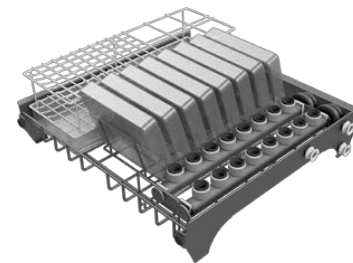
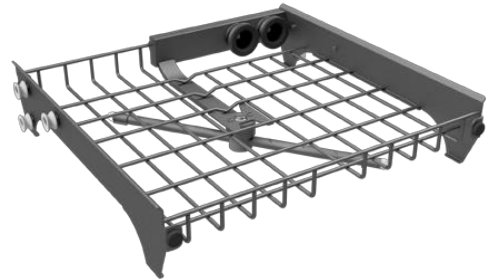

Configuration example with:
 1x A053 + 1x A063 + 1x A076 + 2x A075

TH153 UPPER WASH RACK 4 CONN.

Washing rack positioned on the upper level, with 4 connection and spray arm
 Active drying of turbines, hand-pieces and contra-angles.

For various inserts and accessories.

Product code	119905153
Internal loading dimensions with 2x A076 WxDxH	220x460x185 mm
Internal loading dimensions without A076 WxDxH	480x430x185 mm
Rack external dimensions WxDxH	532x524x110 mm
Empty rack weight	5 Kg

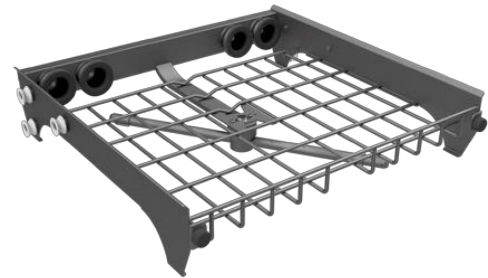

Configuration example with:
 2x A076 + 4x A075 + 1x A085

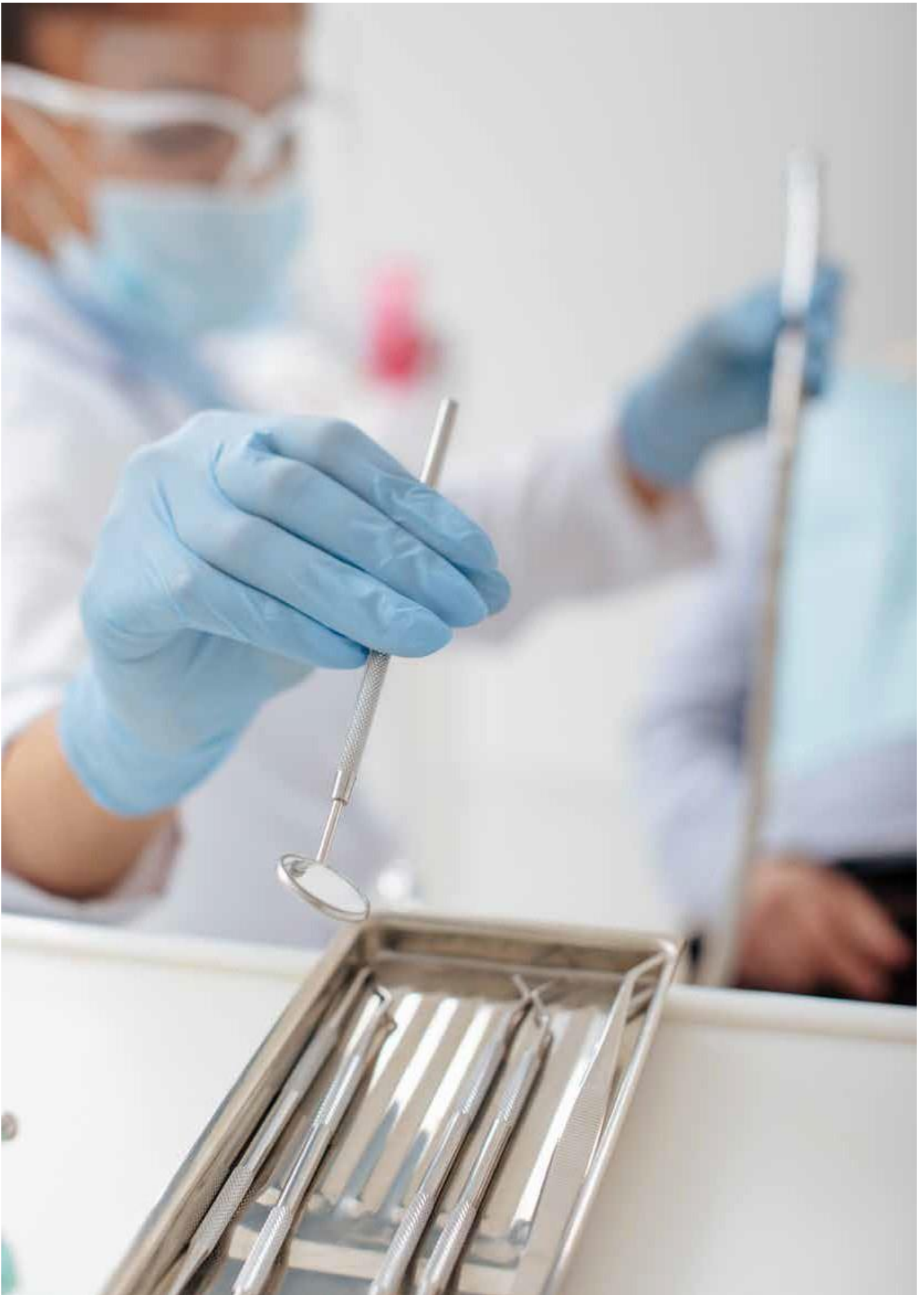

Accessories

A076 INSERT FOR HANDPIECES HOLDER

Insert for 2 holders
 Suitable for use on all racks.
 To be used in combination with:

- A084.
- A075.

Product code	P00001039
Insert external dimension WxDxH	104x455x77 mm

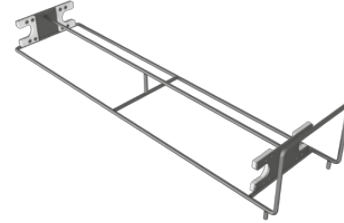

A075 HOLDER 8 POS.

Preassembled holder with 8 positions for handpiece holder
 Includes: S/S FILTER.
 To be used in combination with:

- A076.

Possibility of mounting up:

- 8x A066.
- 8x A079.
- 8x A127.
- 8x A135.

Product code	P00001048
--------------	-----------



A084 HOLDER 12 POS.

Preassembled holder with 12 positions for handpiece holder
 Includes: S/S FILTER.
 To be used in combination with:

- A076.

Possibility of mounting up:

- 12x A066.
- 12x A127.
- 6x A079 + 6x A066.
- 6x A067 + 6x A135.
- 12x A135.

Product code	P00001098
--------------	-----------



A079 SUPPORT HANDPIECES HOLDER

To be used in combination with:

- A075.
- A084.

Product code	D00503600
--------------	-----------

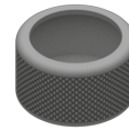

A077 HANDPIECES ADAPTER Ø19-21

Adapter for handpieces with dimension from \varnothing 19 to \varnothing 21 mm
 To be used in combination with:

- A079.

Product code	D00503900
--------------	-----------

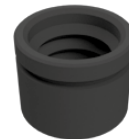

A078 HANDPIECES ADAPTER Ø14-17

Adapter for handpieces with dimension from \varnothing 14 to \varnothing 17 mm
 To be used in combination with:

- A079.

Product code	D00504000
--------------	-----------

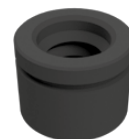

A067 HANDPIECES CAP

To be used in combination with:

- A077.
- A078.

Product code	D00503500
--------------	-----------

**A080 SUPPORT FOR 8 SCALER TIPS**

To be used in combination with:

- A077.

Product code	P00001066
--------------	-----------

**A139 SUPPORT FOR SILICONE CONN.**

To be used in combination with:

- A075.
- A084.
- A138.

Product code	D00564000
--------------	-----------

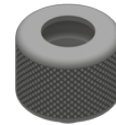
**A138 SILICONE CONN.**

To be used in combination with:

- A139.

Product code	D00291500
--------------	-----------

**A140 CAP FOR SILICONE CONN.**

To be used in combination with:

- A138.

Product code	D00109200
--------------	-----------

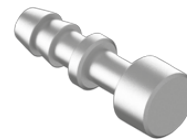
**A066 NOZZLE FOR ASPIRATOR TIPS**

To be used in combination with:

- A075.
- A084.

Product code	D00505300
--------------	-----------

Nozzle external dimension	∅ 4 x H80 mm
---------------------------	--------------

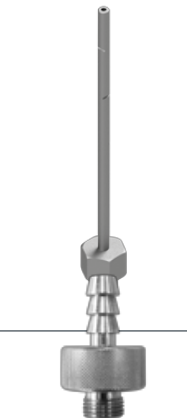
**A142 ADAP. HOSE 1/4" TO G1/8" M. THREAD**

Stainless steel hose male holder adapter DN 5 and DN 6

Product code	D00606500
--------------	-----------

A127 ADAP. M. LUER TO G1/8" M. THREAD

Stainless steel male Luer-Lock adapter

Product code 467010016



A129 PVDF F LUER TO 3/16" HOSE HOLDER

PVDF hose holder DN 5 to female Luer-Lock

Product code 467010018



A131 PVDF M. LUER TO 3/16" HOSE HOLDER

PVDF hose holder DN 5 to male Luer-Lock

Product code 467010019



A149 M. LUER TO 1/4" HOSE HOLDER

Stainless steel hose holder DN 6 to male Luer-Lock

Product code D00341100



A132 PVDF F. LUER TO 1/4" HOSE HOLDER

PVDF hose holder DN 6 to female Luer-Lock

Product code 467010020



A133 PVDF M. LUER TO 1/4" HOSE HOLDER

PVDF hose holder DN 6 to male Luer-Lock

Product code 467010021



A134 PVDF ELBOW FITTING 1/4" HOSE HOLDER

PVDF elbow hose holder DN 6

Product code 467010022



A147 PVDF F. LUER CAP

PVDF female Luer-Lock cap

Product code 467010023

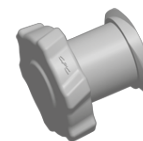

A148 PVDF M. LUER CAP

PVDF male Luer-Lock cap

Product code 467010024

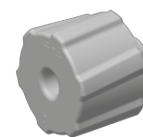

A144 FITTING 3/16" HOSE HOLDER

Stainless steel pass trough hose holder DN 5

Product code	D00304700
--------------	-----------

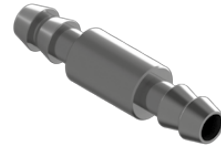
**A081 LUER-LOCK CONNECTOR KIT**

Suitable for use with racks:

- TH121.
- TH123.

Specifications: Female Luer-Lock connection at the end of the pipe.

Product code	P00001069
--------------	-----------

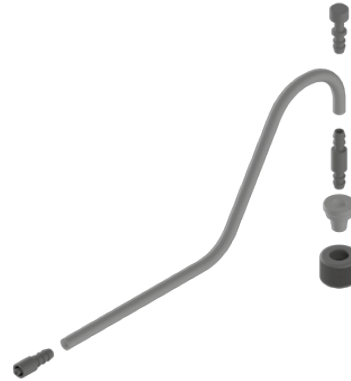
**A135 CAP SCREW G1/8"**

To be used in combination with:

- A075.
- A084.

Product code	421090103
--------------	-----------

**A069 NEMA HANDPIECES ADAPTER**

It allows to have the perfect inside channels cleaning through water circulation.

To be used in combination with:

- A077.
- A078.

Product code	P00000952
--------------	-----------

**A073 BASKET WITH LID**

Rinsing basket with fixed lid for small accessories

Made of high-quality stainless-steel wire for storing small parts and accessories during the cleaning process.

Product code	465060126
--------------	-----------

Basket external dimension WxDxH	80x80x40 mm
---------------------------------	-------------

**A068 INSERT FOR 10 DENTAL IMPRESSION**

Suitable for use on all racks.

Product code	D00505400
--------------	-----------

Insert external dimension WxDxH	184x131x130 mm
---------------------------------	----------------

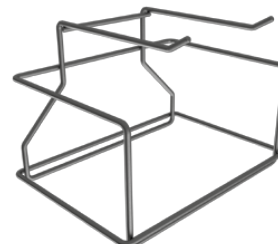

A071 INSERT FOR 7 EXTRACTION PLIERS

Suitable for use on all racks.

Product code	D00525500
Insert external dimension WxDxH	184x131x122 mm

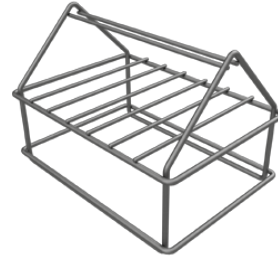

A055 INSERT FOR 9 TRAYS

Suitable for use on all racks.

Product code	D00432900
Insert external dimension WxDxH	455x245x127 mm

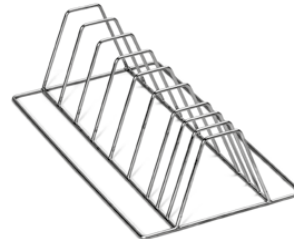

A063 INSERT 8 CASSETTES

Insert with 8 positions for trays or cassettes with width max 35 mm
 Suitable for use on all racks.

Product code	D00480400
Insert external dimension WxDxH	180x370x105 mm

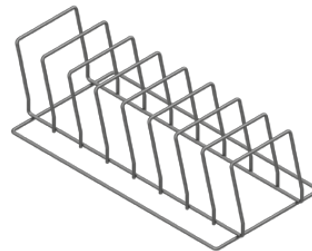

A070 INSERT 7 POS.

Insert with 7 positions for trays or cassettes with width max 40 mm
 Suitable for use on all racks.

Product code	D00522300
Insert external dimension WxDxH	180x370x105 mm

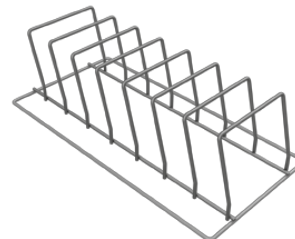

A088 INSERT 3 POS.

Insert with 3 positions for trays or cassettes with width max 40 mm
 Suitable for use on all racks.

Product code	D00600300
Insert external dimension WxDxH	180x360x135 mm

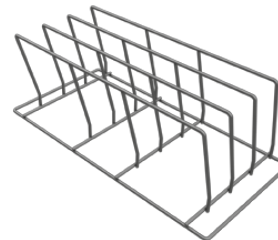

A065 INSERT 3 CASSETTES

Insert with 3 positions for trays or cassettes with width max 35 mm
Suitable for use on all racks.

Product code	D00502900
Insert external dimension WxDxH	170x255x140 mm

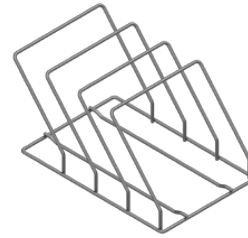

A087 BASKET SPACERS

To be used in combination with:

- A082.
- A083.
- A085.

Specifications: used to stock 2 baskets A083 or 2 baskets A082 or 2 baskets A085.

Product code	K00000613
---------------------	------------------



A053 INSERT FOR VERTICAL INSTRUMENTS

Suitable for use on all racks.

Product code	D00552800
Insert external dimension WxDxH	445x165x120 mm

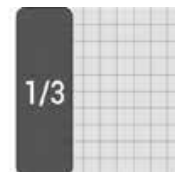
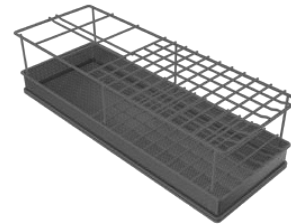

Space requirements into the rack

A085 1/3 BASKET

Dental basket 1/3 For various inserts and accessories.
Suitable for use on all racks.

Product code	D00594900
Insert external dimension WxDxH	455x165x40 mm

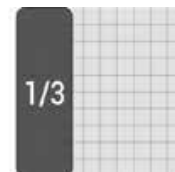

Space requirements into the rack

A054 BASKET WITH 2 SILICONE SUPPORT

Stainless steel basket with two silicone supports.
Suitable for use on all racks.

Product code	465060123
Basket external dimension WxDxH	200x280x30 mm

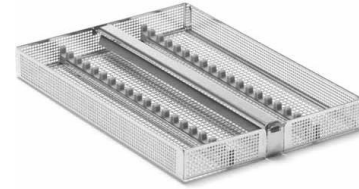

A136 STAINLESS STEEL STAND

Stand for AWD655-8 (and variants) provide an ergonomics height of 146 cm, when the machine is not installed undercounter. Suitable for use as a detergent storage compartment.

Product code	119904062
Stand external dimension WxDxH	600x585x600 mm



A137 STAINLESS STEEL STAND L VERS.

Stand for AWD655-8L (and variants) provide an ergonomics height of 146 cm, when the machine is not installed undercounter. Suitable for use as a detergent storage compartment.

Product code	119904063
Stand external dimension WxDxH	900x585x600 mm



KIT DISPENSER VALIDATION

Kit for calibrating dispensers.

Product code	P00001065
---------------------	------------------



TIVA8-MD

Datasheets racks, accessories and spare parts



Spare parts

S/S FILTER

To be used in combination with:

- A075.
- A084.

Product code

D00491700

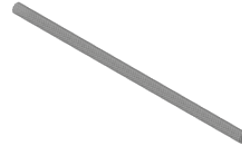

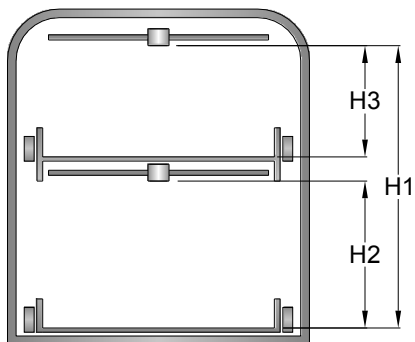

DOUBLE LEVEL WITHOUT HOLDER AND SUPPORT FOR HANPIECES ACCESSORIES

Configuration example: TH151+ TH148

H1	470 mm
H2	230 mm
H3	185 mm

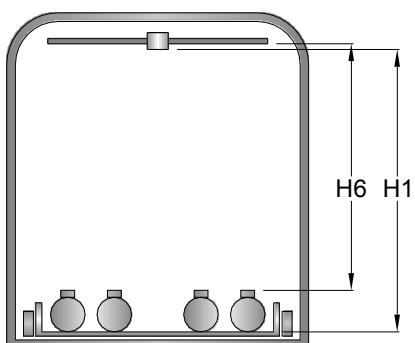

LOWER LEVEL WITH HOLDER AND SUPPORT FOR HANPIECES ACCESSORIES

Configuration example: TH157

H1	470 mm
H6	415 mm

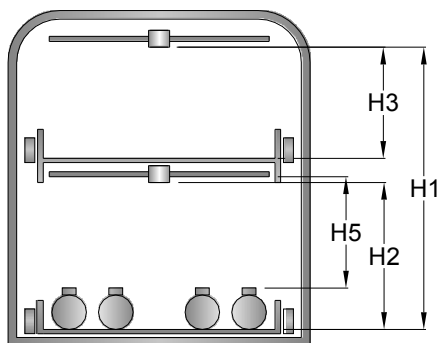

**LOWER LEVEL WITH HOLDER AND SUPPORT FOR HANPIECES ACCESSORIES
 UPPER LEVEL WITHOUT HOLDER AND SUPPORT FOR HANPIECES ACCESSORIES**

Configuration example: TH157 + TH148

H1	470 mm
H2	230 mm
H3	185 mm
H5	174 mm

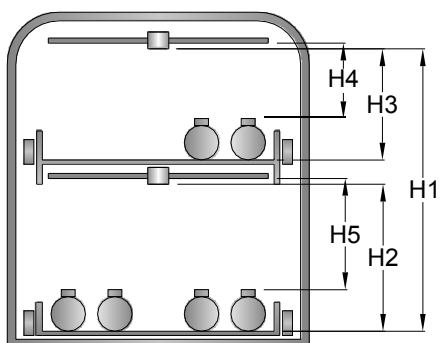

DOUBLE LEVEL WITH HOLDER AND SUPPORT FOR HANPIECES ACCESSORIES

Configuration example: TH157 + TH149

H1	470 mm
H2	230 mm
H3	185 mm
H4	130 mm
H5	174 mm

HOSPITAL

CSSD

RETIREMENT HOMES

DRYING CABINETS

DENTAL

LABORATORY

VETERINARY

STAINLESS STEEL FURNITURE



Authorized Tuttnauer Distributor Since 1992

39 Western Highway, West Nyack, NY 10994

877-561-0500

sales@duralinesystems.com | www.duralinesystems.com